

Ausdrehen

Geeignet ab Bohrungsdurchmesser 4,2 mm.

Boring

For use in bores as of minimum bore diameter 4,2 mm.

Schnittwerte (Start) // Cutting parameters (start)

f	Vc
0,02 mm/U	(Seite/Page 442)

Passende Klemmhalter auf Seite // Suitable toolholders on page

45, 46, 48, 54, 55, 57, 64, 65, 68, 69, 70, 73, 75, 76, 79, 80, 81

Vergleichbare Werkzeuge auf Seite // Similar tools on page

82

SP
HM
R

Legende
Legend **155**

Scan QR-Code Oder besuchen Sie // Or Visit www.simtek.info/cp/1040



Abbildung zeigt / Drawing shows: A04.1820.30.42.05 Y R/L

Mehr Informationen zur Kühlmittelzufuhr finden Sie auf Seite 36
Additional information about through coolant supply on page 36

ØD	L2	ØDmin (Min. Bohrung) ØDmin (min. bore)	R	Kühlmittelzufuhr Through coolant supply	Artikelnummer Part number	Webcode www.simtek.com/webcode	Empfohlene Schneidstoffe Recommended cutting grades	a	d	f	LH	tmax	Connectcode www.simtek.com/code
mm	mm	mm	mm				PKMNSHO	mm	mm	mm	mm	mm	

Fortgesetzte Tabelle
Continued Table

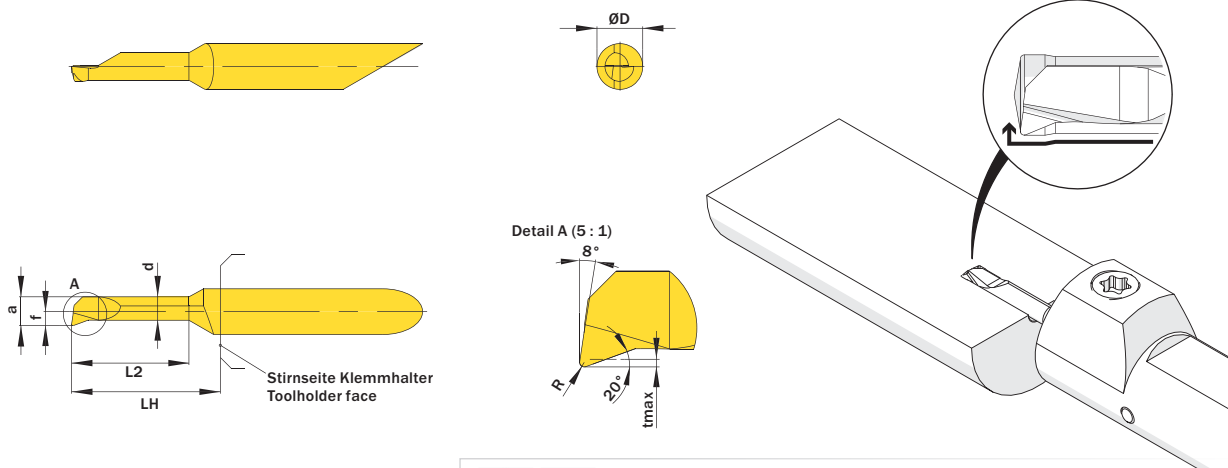
Verwandte Werkzeuge finden Sie auch auf der vorhergehenden Seite!
Related items can be found on the previous page as well!

4,0	10,2	4,2	0,03	+	A04.1820.10.42.03 YR/L	R AGCF L ABGP	X800 X600	GX79 X500 X400	3,95	3,45	1,95	13,0	0,3	R A04C.R	L A04C.L
4,0	10,2	4,2	0,05	+	A04.1820.10.42.05 YR/L	R ADDK L AN4X	X800 X600	GX79 X500 X400	3,95	3,45	1,95	13,0	0,3	R A04C.R	L A04C.L
4,0	10,2	4,2	0,15	+	A04.1820.10.42.15 YR/L	R AEH9 L AAPJ	X800 X600	GX79 X500 X400	3,95	3,45	1,95	13,0	0,3	R A04C.R	L A04C.L
4,0	15,2	4,2	0,03	+	A04.1820.15.42.03 YR/L	R APUB L AKMA	X800 X600	GX79 X500 X400	3,95	3,45	1,95	18,0	0,3	R A04C.R	L A04C.L
4,0	15,2	4,2	0,05	+	A04.1820.15.42.05 YR/L	R ADN4 L AK2B	X800 X600	GX79 X500 X400	3,95	3,45	1,95	18,0	0,3	R A04C.R	L A04C.L
4,0	15,2	4,2	0,15	+	A04.1820.15.42.15 YR/L	R AHDX L AGEY	X800 X600	GX79 X500 X400	3,95	3,45	1,95	18,0	0,3	R A04C.R	L A04C.L
4,0	20,3	4,2	0,03	+	A04.1820.20.42.03 YR/L	R AJØB L AEPY	X800 X600	GX79 X500 X400	3,95	3,45	1,95	23,0	0,3	R A04C.R	L A04C.L
4,0	20,3	4,2	0,05	+	A04.1820.20.42.05 YR/L	R AB3A L AHMG	X800 X600	GX79 X500 X400	3,95	3,45	1,95	23,0	0,3	R A04C.R	L A04C.L
4,0	20,3	4,2	0,15	+	A04.1820.20.42.15 YR/L	R AM3K L ANGF	X800 X600	GX79 X500 X400	3,95	3,45	1,95	23,0	0,3	R A04C.R	L A04C.L
4,0	25,4	4,2	0,05	+	A04.1820.25.42.05 YR/L	R AMVØ L AFE8	X800 X600	GX79 X500 X400	3,95	3,45	1,95	28,0	0,3	R A04C.R	L A04C.L
4,0	25,4	4,2	0,15	+	A04.1820.25.42.15 YR/L	R AJT1 L AJ4S	X800 X600	GX79 X500 X400	3,95	3,45	1,95	28,0	0,3	R A04C.R	L A04C.L
4,0	30,5	4,2	0,05	+	A04.1820.30.42.05 YR/L	R ASFY L ASF1	X800 X600	GX79 X500 X400	3,95	3,45	1,95	33,0	0,3	R A04C.R	L A04C.L
4,0	35,6	4,2	0,05	+	A04.1820.35.42.05 YR	A2AF	X800 X600	GX79 X500 X400	3,95	3,45	1,95	38,0	0,3	A04C.R	

Verwandte Werkzeuge finden Sie auch auf der folgenden Seite!
Related Items can be found on the following page as well!

Fortgesetzte Tabelle
Continued Table

Bestellbeispiel // Order example: A04.1820.10.42.15 YR X800 (R = Rechte Ausführung // Right hand version, X800 = Schneidstoff // Grade)